

WORLEY'S

LIGHTING



Protea Pendant II 8"

OVERVIEW

The Protea II collection is the next iteration of our classic Protea lights and use easy to install screw on glass globes.

Certifications	UL and cUL damp locations
Lamping	(1) E26, 60W, Bulb not included
Mounting	4", Universal
Lead Time	2-3 weeks
Dimensions	8" depth, 8" width, 24.5" height
As Shown	White Oak, Mixed Metal- Coated Bronze and Satin White

WORLEYSLIGHTING.COM
TRADE@WORLEYSLIGHTING.COM



DIMENSIONS

Overall	8" depth, 8" width, 24.5" height
Canopy	5" diameter .75" depth
Shade	8" diameter, 4" height
Down Rod	16"
Materials	Wood, Brass or powder coated steel and aluminum, Glass
Origin	Made in USA of U.S. and imported parts

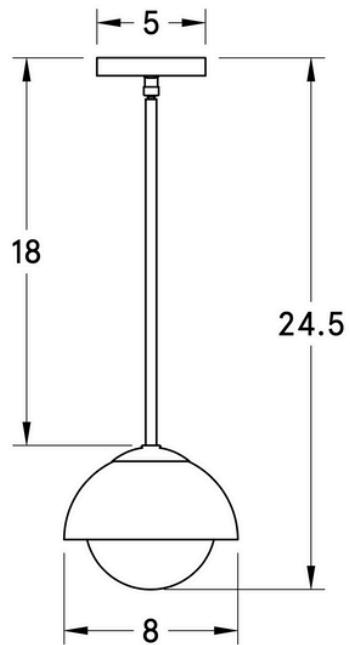

FINISHES

Our fixtures come in a variety of wood, metal, porcelain, linen and glass finishes. To discover what finishes are available for this fixture, click the link below or visit the product page on worleyslighting.com.

PROTEA PENDANT II 8" FINISH OPTIONS

Finish samples are available at worleyslighting.com/finishes. For pricing and purchasing, please visit worleyslighting.com or contact us with further questions.